

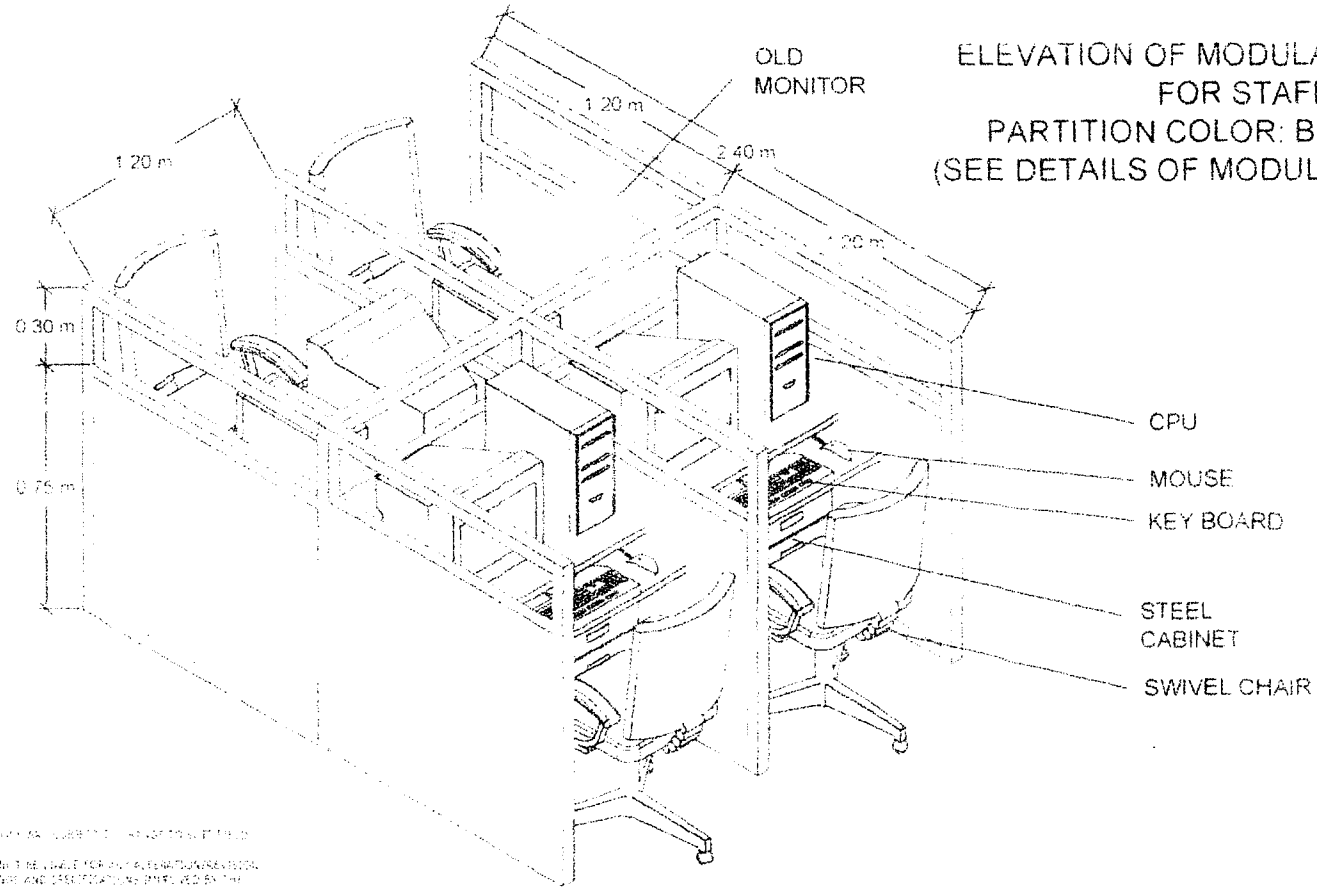

ELEVATION OF MODULAR PARTITION
FOR STAFF
PARTITION COLOR: BLUE COLOR
(SEE DETAILS OF MODULAR PARTITION)



NOTE:
1. ALL DIMENSIONS ARE IN METERS UNLESS OTHERWISE SPECIFIED.
2. THE DESIGNER SHALL BE LIABLE FOR ANY ERRORS OR OMISSIONS AND THE SUPERVISORS AND CONSULTANTS EMPLOYED BY THE AUTHORIZED SUPERVISING ENGINEER WORK WITHOUT THEIR KNOWLEDGE THAT THEY ARE PART OF THE DESIGN OF THE PROJECT.

 CALAMBA WATER DISTRICT ENGINEERING DEPARTMENT PLANNING AND DESIGN DIVISION LAKEVIEW SUBD., TALANG, CALAMBA CITY	PROJECT TITLE:	AUTOCAD BY: ENGR. K. CERVANCIA	SHEET CONTENTS:	DATE:
	PROPOSED OFFICE MODULAR PARTITION	DESIGNED BY: ENGR. K. CERVANCIA	PERSPECTIVE	10.17.2016
	LOCATION:	CHECKED BY: ENGR. R.S. CARTAGO		SHEET NO.
	CALAMBA CITY, LAGUNA	RECOMMENDED BY: ENGR. R.S. CARTAGO	A-2	
	APPROVED BY: ENGR. R.B. SUMANGA			

ELEVATION OF MODULAR PARTITION
(FOR DIVISION MANAGERS)
PARTITION COLOR: BLUE

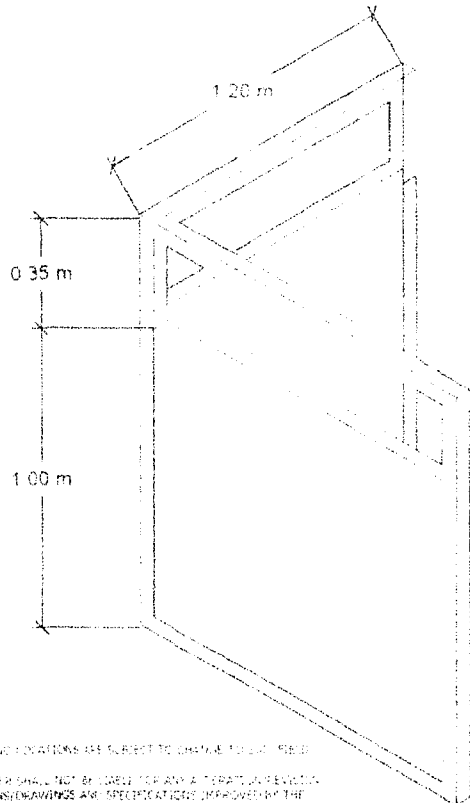

- (1) MID-BACK CHAIR WITH ARMS
-PNEUMATIC LIFT, 360° SWIVEL
-RECLINE/ TILT MECHANISM
-FABRIC FINISH BACK & SEAT
-NYLON STAR BASE WITH CASTER

QUANTITY: 4 (FOUR) PCS

- (2) HIGH BACK CHAIR WITH ARMS
-PNEUMATIC LIFT, 360° SWIVEL
-RECLINE/ TILT MECHANISM
-FABRIC FINISH BACK & SEAT
-NYLON STAR BASE WITH CASTER

QUANTITY: 1 (ONE) PC

NOTES:
1. ALL SIZES AND LOCATIONS ARE SUBJECT TO CHANGE TO MEET FIELD CONDITIONS.
2. THE DESIGNER SHALL NOT BE LIABLE FOR ANY ALTERATION OR EVIDENCE ON THE PLANS/DRAWINGS AND SPECIFICATIONS APPROVED BY THE AUTHORIZED SUPERVISING ENGINEER CONCERNING THEIR NEGLIGENCE THAT MAY IMPAIR THE EXECUTION OF THE PROJECT.

 <p>CALAMBA WATER DISTRICT ENGINEERING DEPARTMENT PLANNING AND DESIGN DIVISION</p>	PROJECT TITLE:	AUTOCAD BY: ENGR. K. CERVANCIA	SHEET CONTENTS:	DATE:
	PROPOSED OFFICE MODULAR PARTITION	DESIGNED BY: ENGR. K. CERVANCIA <i>K. Cervancia</i>	PERSPECTIVE	10.17.2016
	LOCATION:	CHECKED BY: ENGR. R. S. CARTAGO		SHEET NO.
	CALAMBA CITY, LAGUNA	RECOMMENDED BY: ENGR. R. S. CARTAGO		A-3
LAREVIEW SUBD. - HALANG, CALAMBA CITY		APPROVED BY: ENGR. R. B. SUMANGA <i>R. B. Sumanga</i>		

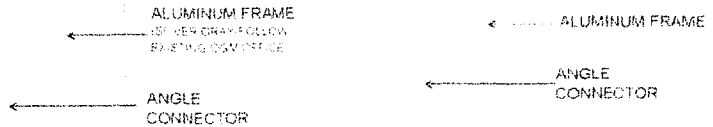

ANGLE CONNECTOR FOR 3-WAY CONNECTIONS

ANGLE CONNECTOR FOR 4-WAY CONNECTIONS

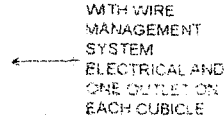

FLOOR-PANEL CONNECTION

- 3 DRAWER
 -MOBILE PEDESTAL
 -STEEL BALL BEARING MECHANISM
 -LOCK
 -ONE LOCK ALL DRAWER
 -POWDER COATED
 -OFFWHITE FINISH
 -ED GAUGE # 20
 -W40 D50 H85 CH

PEDESTAL CABINET DETAILS
 QUANTITY 25 PCS

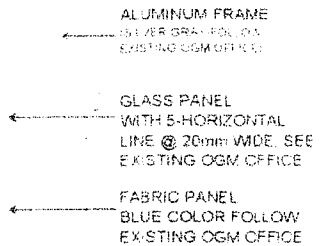

FABRIC PARTITION 1m(H) WITH TOP GLASS PANEL 0.35m(H). MONOTONE SILVER GRAY (SEE PLAN FOR SIZES)

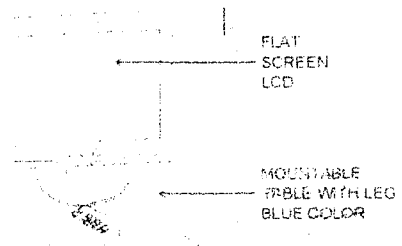

FREESTANDING TABLE 25MM THICK & MOUNTABLE BLUE COLOR FOLLOW EXISTING OGM OFFICE LEGS VARIABLE WIDTH 60CM(D)

- TASK CHAIR WITH ARMS
 -PNEUMATIC LIFT
 -NORMAL TILT
 -FABRIC FINISH
 -BACK & SEAT
 -5-PRONGED STAR
 -NYLON BASE

STAFF CHAIR
 QUANTITY 20PCS

DETAILS OF MODULAR PARTITION

NOTES
 1. ALL SIZES AND LOCATIONS ARE SUBJECT TO CHANGE TO FIT FIELD CONDITIONS
 2. THE DESIGNER SHALL NOT BE LIABLE FOR ANY ALTERATIONS MADE ON THE PLANS/DRAWINGS AND SPECIFICATIONS APPROVED BY THE AUTHORIZED SUPERVISING ENGINEER'S CONCERNING THEIR KNOWLEDGE THAT MAY IMPAIR THE STRENGTH OF THE PROJECT

<p>CALAMBA WATER DISTRICT ENGINEERING DEPARTMENT PLANNING AND DESIGN DIVISION</p>	PROJECT TITLE:	AUTOCAD BY: ENGR. K. CERVANCIA	SHEET CONTENTS:	DATE:
	PROPOSED OFFICE MODULAR PARTITION	DESIGNED BY: ENGR. K. CERVANCIA	DETAILS	10.17.2016
	LOCATION:	CHECKED BY: ENGR. R.S. CARTAGO		SHEET NO.
	CALAMBA CITY, LAGUNA	RECOMMENDED BY: ENGR. R.S. CARTAGO	A-4	
LAKEVIEW SUBD., HALANG, CALAMBA CITY		APPROVED BY: ENGR. R.B. SUMANGA		